

Problem

- The current system does not provide a convenient user interface for registration
 - The user must click the "Login" icon to log into the VIRS system after registering
 - The user's email is not required when registering

Current System

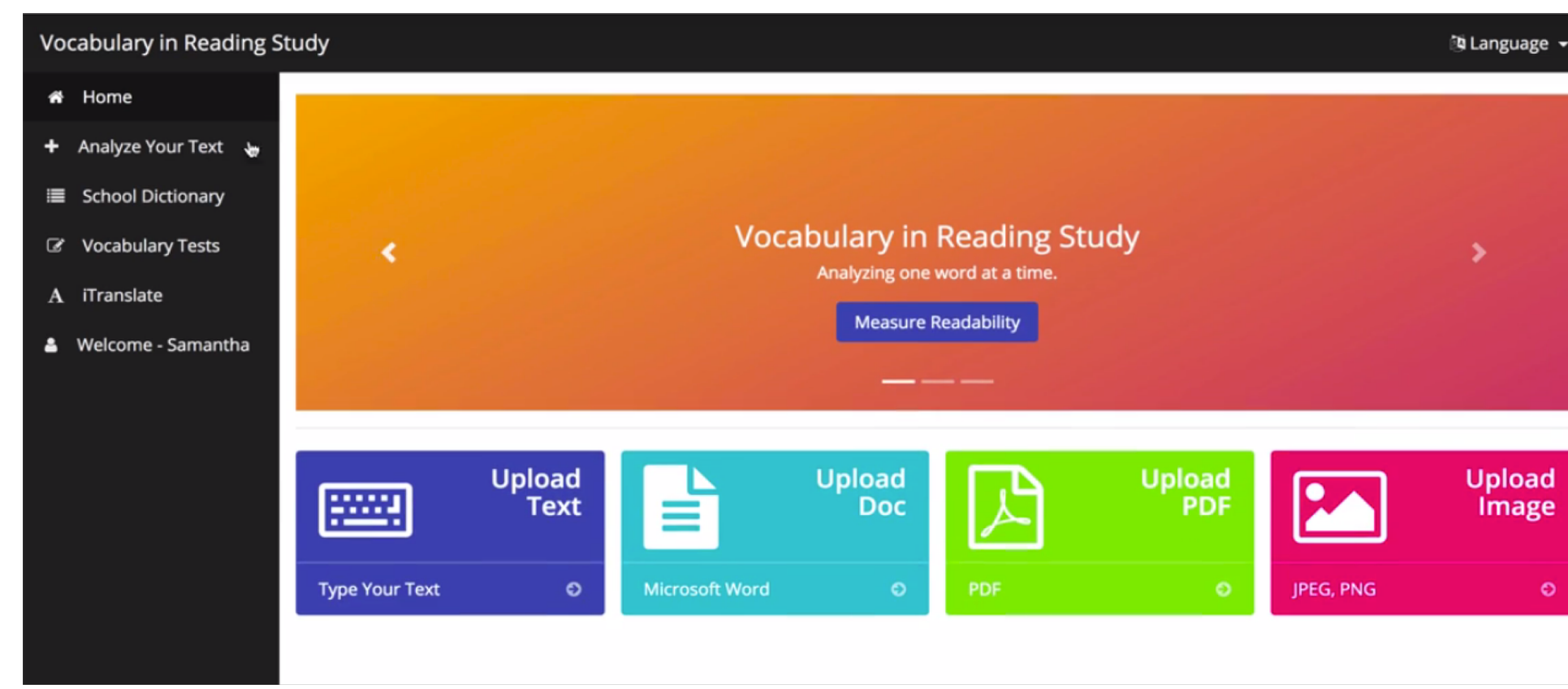

Requirements

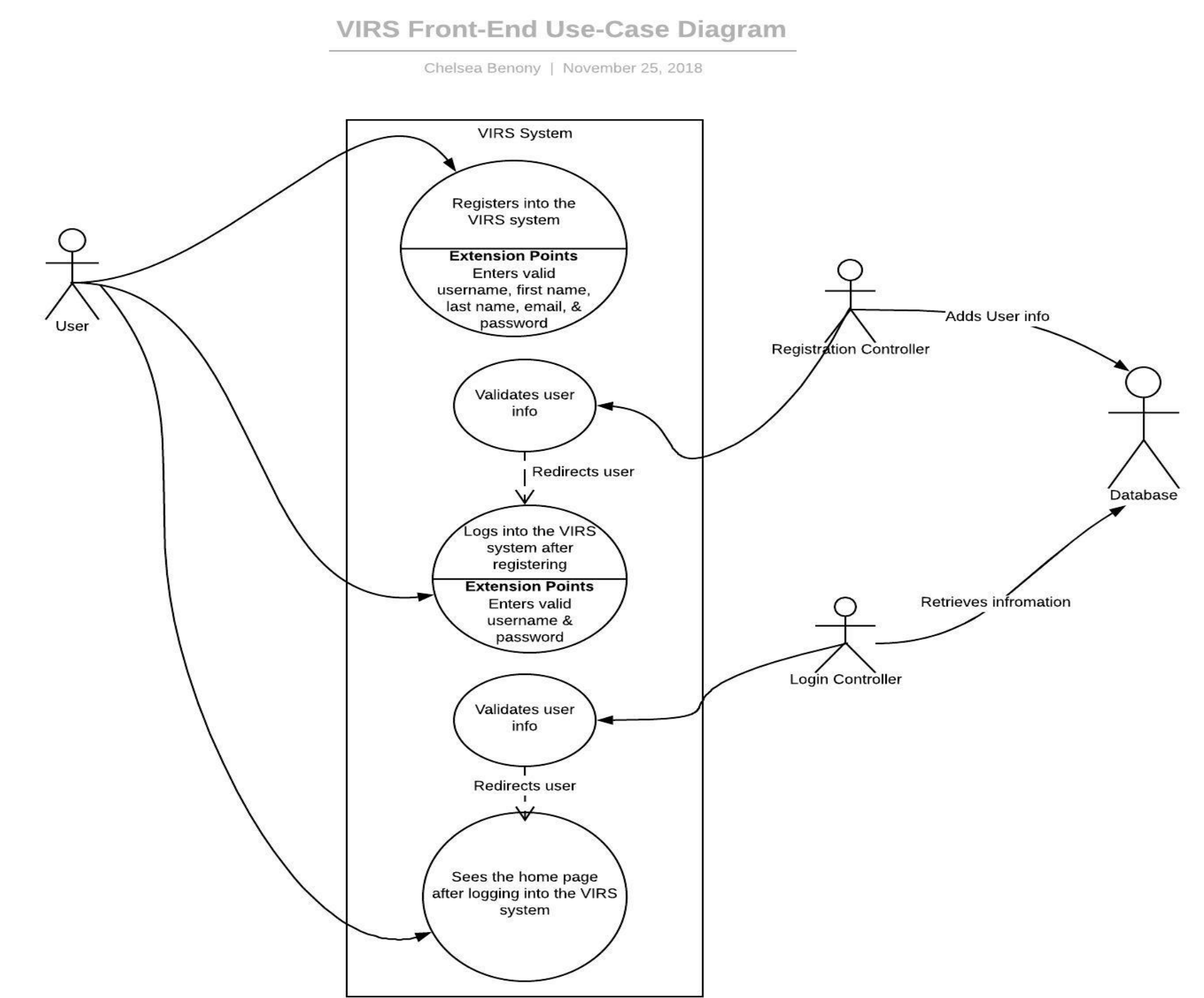

- As a User, I want to log into the system after registration.
- As a User, I want my email to be required.

System Design

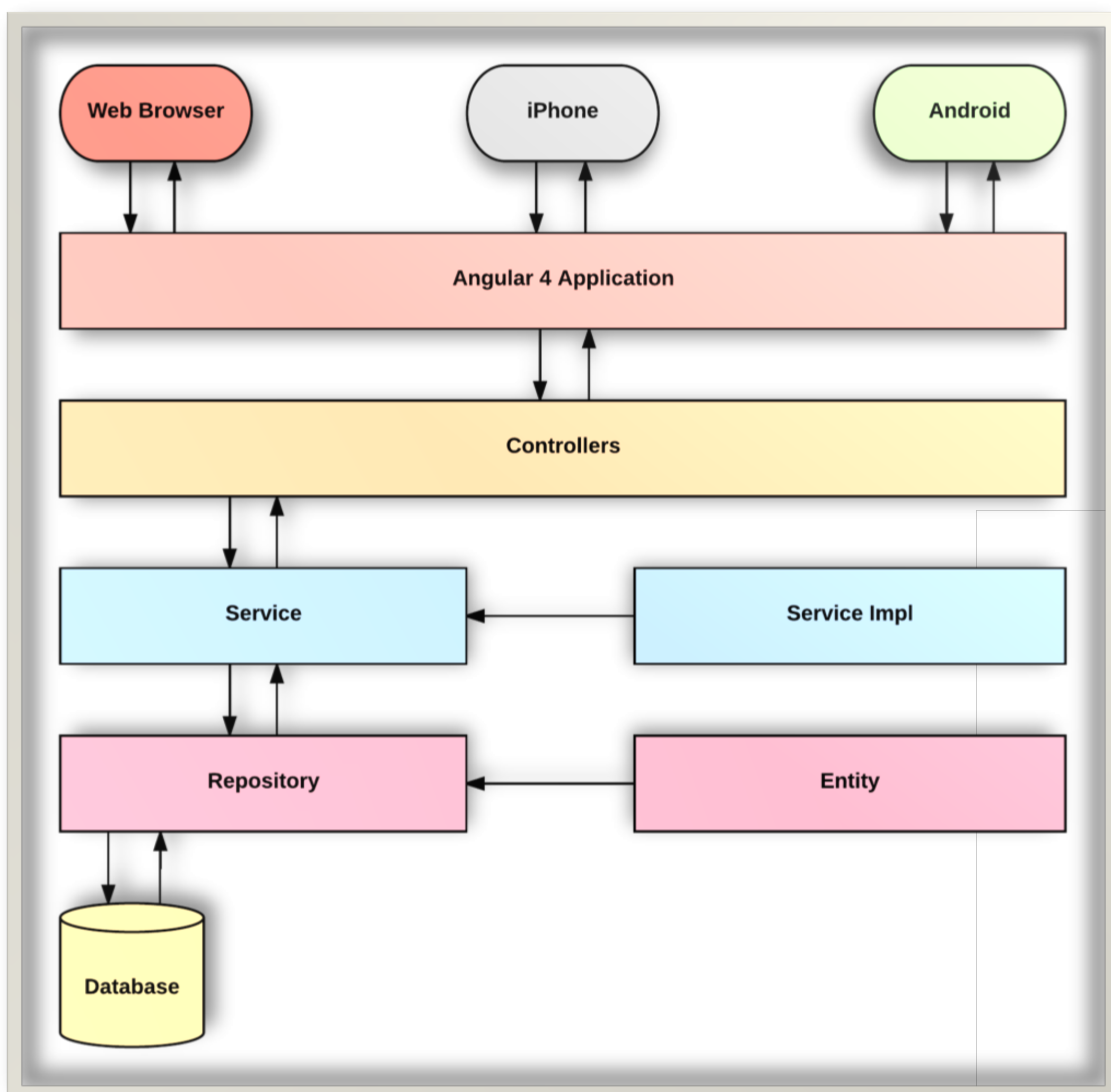

- The current system is available as a Web application, along with Android and iPhone
- VIRS 4.0 allows user to log in after registration.
- VIRS 4.0 requires email from user when the user registers.

Object Design

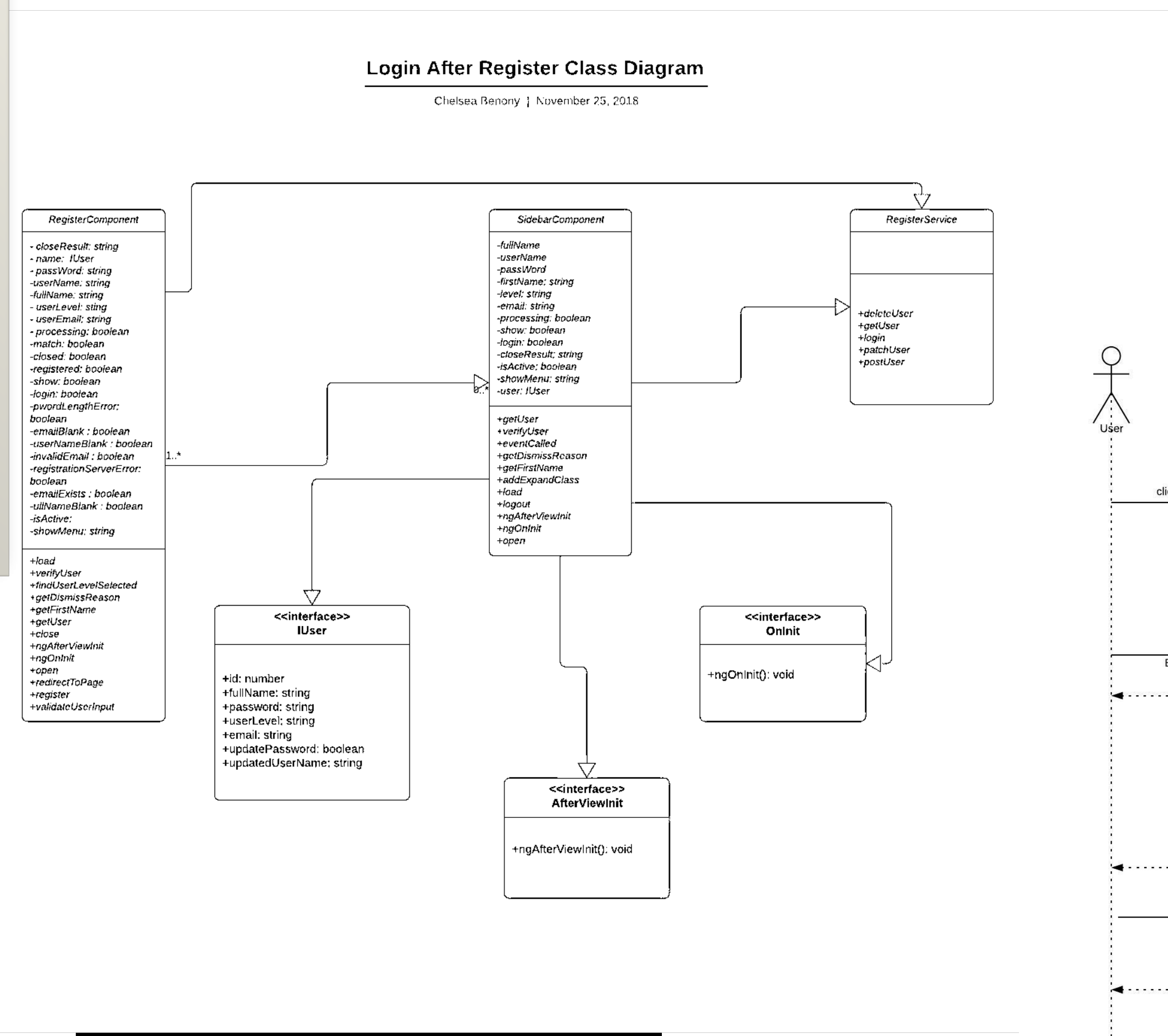

Implementation

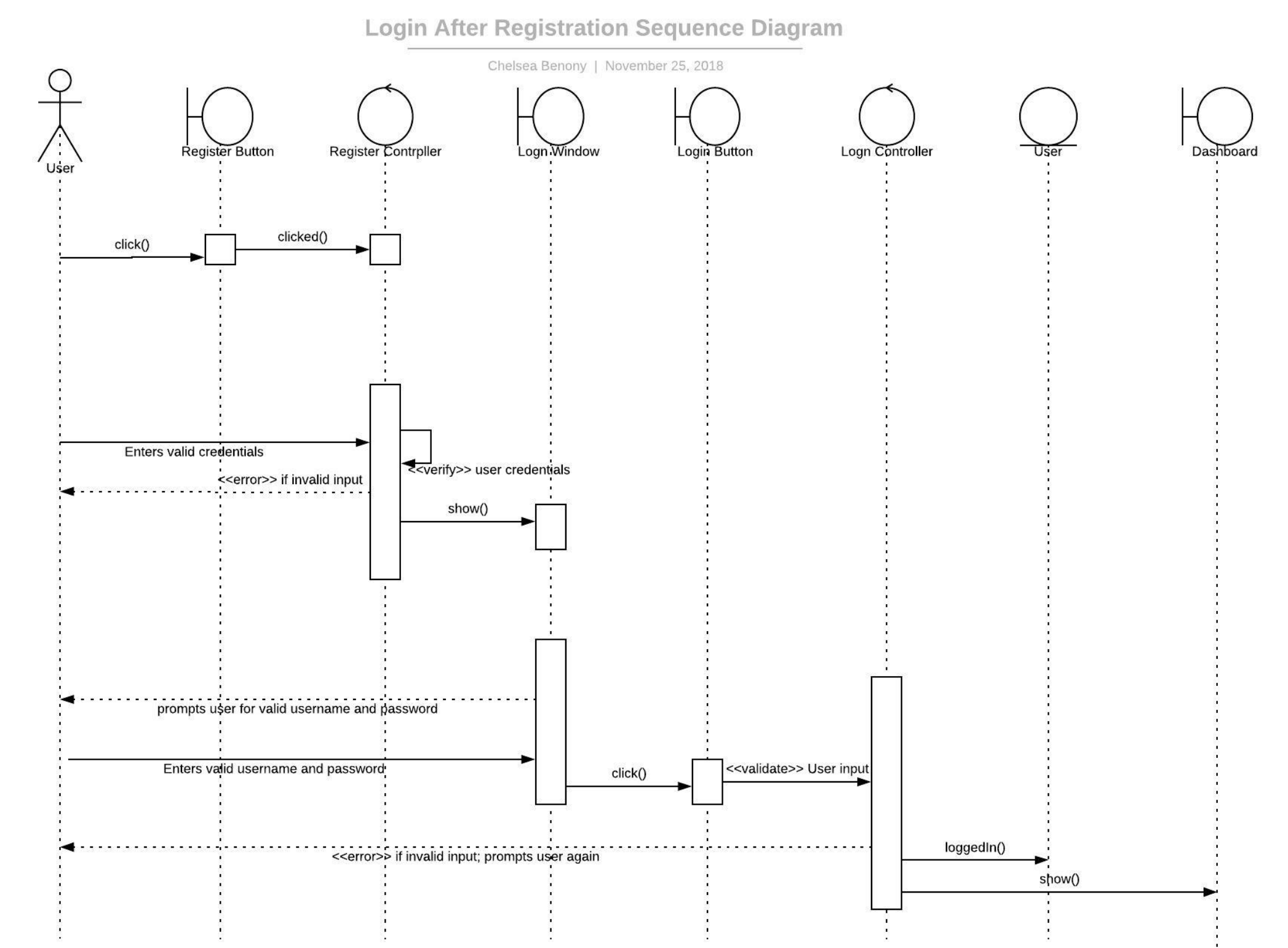

Verification

Karma, along side Jasmine were used to perform the unit testing for the frontend

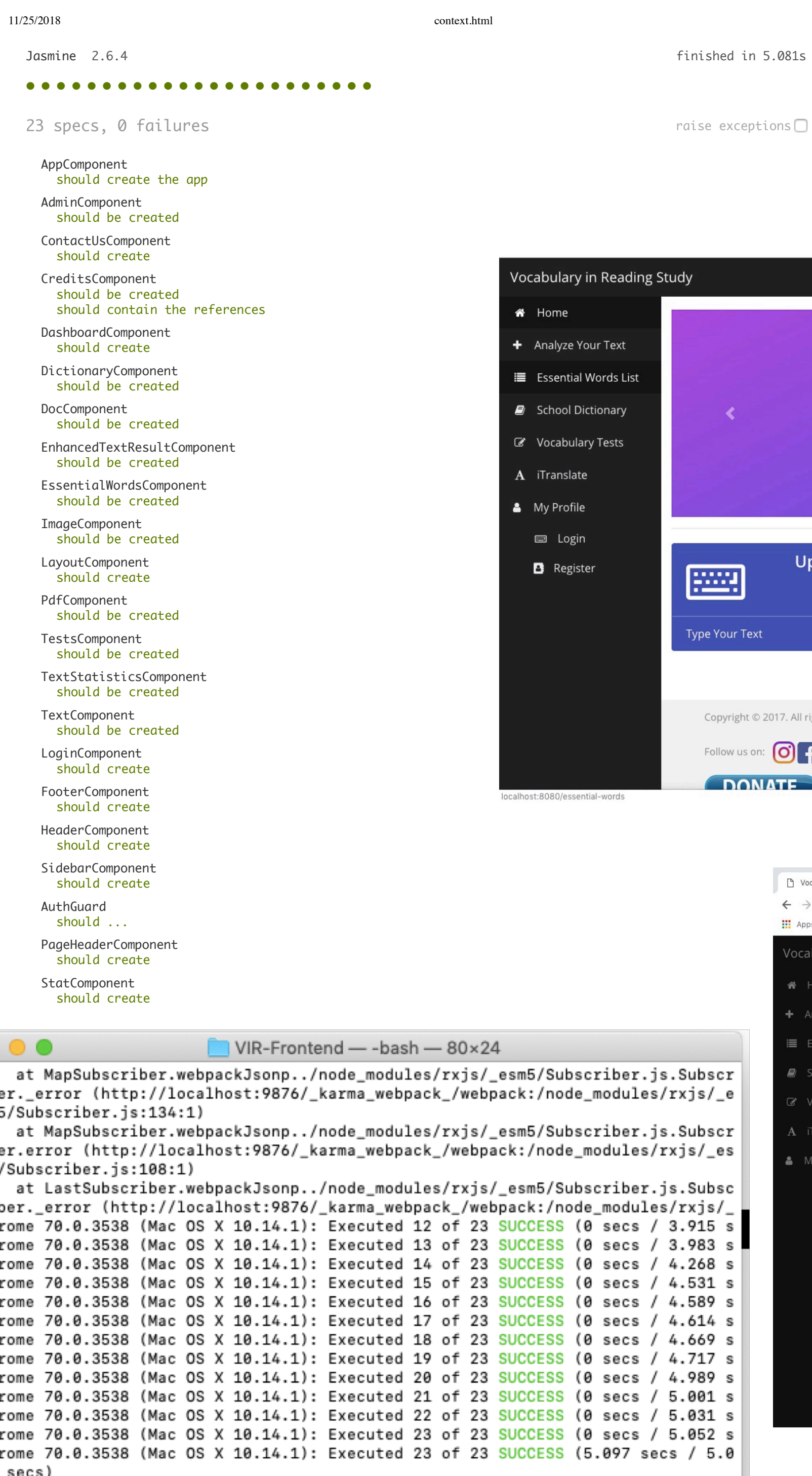

Screenshots

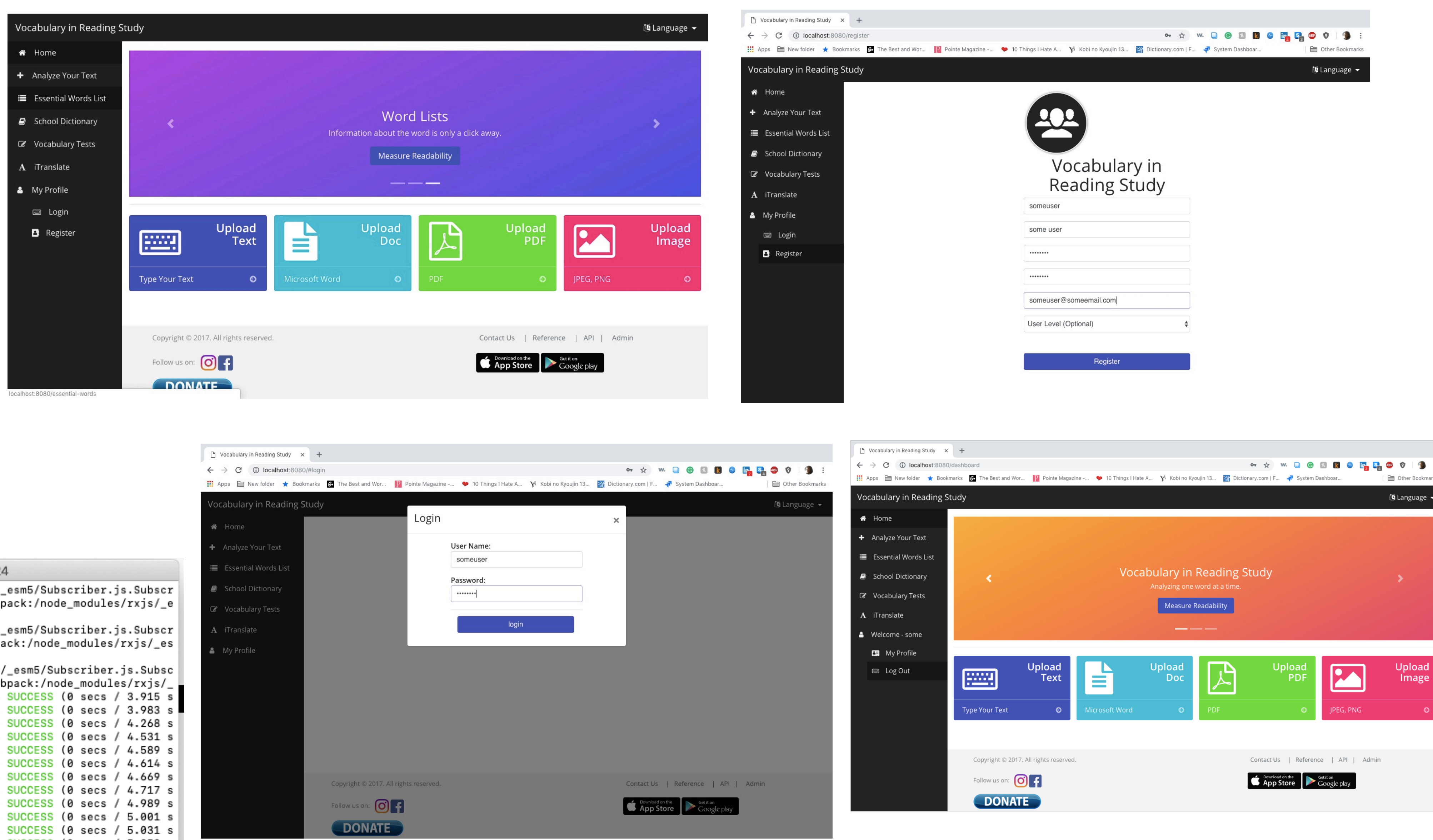

Summary

- VIRS 4.0 now requires a valid email upon registration
- VIRS 4.0 redirects the user to the "Login" page without the user having to click "login" again
- The user has the ability to delete their account
- The user has the ability to change their password
- The user has the ability to update their username and password

Acknowledgement

The material presented in this poster is based upon the work supported by Dr. Masoud Sadjani, Seyedjafar Ehsanzadehsorati, and Aaron Feng at Florida International University. I thank my teammates and Dr. Masoud Sadjani for assistance, cooperation and mentorship that I received throughout this process